

Northumbria Research Link

Citation: Corradi, Marco, Tedeschi, Cristina, Binda, Luigia and Borri, Antonio (2008) Experimental evaluation of shear and compression strength of masonry wall before and after reinforcement: Deep repointing. *Construction and Building Materials*, 22 (4). pp. 463-472. ISSN 0950-0618

Published by: UNSPECIFIED

URL:

This version was downloaded from Northumbria Research Link: <http://northumbria-test.eprints-hosting.org/id/eprint/49072/>

Northumbria University has developed Northumbria Research Link (NRL) to enable users to access the University's research output. Copyright © and moral rights for items on NRL are retained by the individual author(s) and/or other copyright owners. Single copies of full items can be reproduced, displayed or performed, and given to third parties in any format or medium for personal research or study, educational, or not-for-profit purposes without prior permission or charge, provided the authors, title and full bibliographic details are given, as well as a hyperlink and/or URL to the original metadata page. The content must not be changed in any way. Full items must not be sold commercially in any format or medium without formal permission of the copyright holder. The full policy is available online: <http://nrl.northumbria.ac.uk/policies.html>

This document may differ from the final, published version of the research and has been made available online in accordance with publisher policies. To read and/or cite from the published version of the research, please visit the publisher's website (a subscription may be required.)



UniversityLibrary



Northumbria
University
NEWCASTLE

Northumbria Research Link

Citation: Corradi, Marco, Tedeschi, Cristina, Binda, Luigia and Borri, Antonio (2008) Experimental evaluation of shear and compression strength of masonry wall before and after reinforcement: Deep repointing. *Construction and Building Materials*, 22 (4). pp. 463-472. ISSN 0950-0618

Published by: ##publisher##

URL: ##official_url##

This version was downloaded from Northumbria Research Link:
<http://nrl.northumbria.ac.uk/13818/>

Northumbria University has developed Northumbria Research Link (NRL) to enable users to access the University's research output. Copyright © and moral rights for items on NRL are retained by the individual author(s) and/or other copyright owners. Single copies of full items can be reproduced, displayed or performed, and given to third parties in any format or medium for personal research or study, educational, or not-for-profit purposes without prior permission or charge, provided the authors, title and full bibliographic details are given, as well as a hyperlink and/or URL to the original metadata page. The content must not be changed in any way. Full items must not be sold commercially in any format or medium without formal permission of the copyright holder. The full policy is available online: <http://nrl.northumbria.ac.uk/policies.html>

This document may differ from the final, published version of the research and has been made available online in accordance with publisher policies. To read and/or cite from the published version of the research, please visit the publisher's website (a subscription may be required.)

www.northumbria.ac.uk/nrl



Experimental evaluation of shear and compression strength of masonry wall before and after reinforcement: deep repointing

M. Corradi^{*1}, C. Tedeschi², L. Binda³ and A. Borri⁴

¹ Assistant Professor, Department of Civil and Environmental Engineering, University of Perugia, mcorradi@strutture.unipg.it

² Assistant Professor, DIS-Dept. of Structural Engineering, Politecnico of Milan, tedeschi@stru.polimi.it

³ Full Professor, DIS-Dept. of Structural Engineering, Politecnico of Milan, binda@stru.polimi.it

⁴ Full Professor, Department of Civil and Environmental Engineering, University of Perugia, borri@unipg.it

Abstract

Masonry presents some inadequacies due to its almost total lack of tensile strength. Typical damage to multiple leaf walls during earthquakes is the loss of bond between the leaves with consequent collapse of the external leaf. Retrofitting or repair of this damage is a very difficult task. In many cases grout injection or wall jacketing fail due to incompatibility with the construction technique of the walls.

A complementary technique to the grouting has been proposed by the authors. Experimental results and applications of the technique on site have shown positive characteristics and the results of tests carried out on site show, in some cases, increases in shear strength and stiffness of the masonry walls.

Keywords: masonry, shear strength, reinforcement, deep repointing

1. Introduction

Multiple leaf stone masonry structures are widely encountered in Italian and European historic centres. Dwellings but also other important buildings of these centres are characterised by a typical construction technique which is the double leaf wall with transversal connections (diatons). Particularly in the case of dwellings, this connection is frequently missing or very rare due to poor workmanship or lack of large stones crossing the wall section (Fig. 1). So the section of the wall consists of two external leaves with a gap between them filled with mortar, inconsistent material and small pieces of stones. It is now well known by direct experience that under vertical and/or horizontal actions the two leaves tend to separate (Fig. 2) and a partial or total collapse of the wall can take place (out-of-plane mechanisms). This mechanism of collapse has frequently occurred during seismic events in Italy and elsewhere. One of the most difficult tasks for engineers and architects is the repair and/or retrofit of this damage.

Traditional masonry works are also particularly susceptible to in-plane shear actions due to its almost total lack of tensile strength. Therefore, in order to predict properly the masonry shear capacity, it is necessary to first identify the most anticipated failure mechanism, based on the knowledge of the involved materials. A reinforcement work should prevent both out-of-plane collapse mechanisms and in-plane mechanisms.

After the major earthquake which hit Friuli in 1976 and destroyed several historic centres, some reinforcing techniques were proposed to avoid this kind of damages: a) injection of grout in

* Corresponding Author: mcorradi@strutture.unipg.it, fax +39 075 585 3897 (M Corradi)

cases when the external leaves appeared in good conditions, b) injections and jacketing with a reinforced cement rendering when also the bond between the stones of the external leaves were missing, c) partial reconstruction of the walls in the worst cases. These techniques were generally considered correct and have been applied to a large number of monuments and buildings with two-or three-leaf stone masonry walls. The 1997 earthquake, which hit Umbria and Marche in the central part of Italy, allowed to verify the appropriateness and effectiveness of most of the retrofitting techniques. In fact, several centres which had already suffered damage in a 1979 earthquake were retrofitted according to the techniques suggested by the Italian seismic code. Unfortunately partial and total collapses of the repaired masonry structures showed the failure of some inappropriately applied techniques. This was the case of some double leaf walls repaired by injections and/or jacketing. The failure was mainly due to poor workmanship but also to lack of knowledge of the masonry itself. In fact, some injected walls were not injectable due to lack of voids or to the pressure of loose material in the internal part of the section and hence the injection could not connect the two leaves (Fig. 3). In the case of jacketing, it was impossible to connect the two leaves due to the particular geometry of the section (Fig. 4). Other problems typical of jacketing are corrosion of the steel reinforcing net, and poor workmanship in positioning the reinforcing net [1, 2]. Furthermore, in the historic centres, this technique is considered to be invasive for the preservation of the historic heritage.

A repair and preventive technique for double leaf masonry walls is proposed by the authors: the deep repointing of the masonry joints with an appropriate mortar, carried out on the two faces of the masonry. The aim of this repair is to bond the stones of the external leaves, particularly in the case of badly bonded irregular stones and to obtain an external confinement of the wall in order to

increase the masonry shear strength. The repointing can be carried out also in conjunction with grout injection.

Within the framework of extensive research supported by the Deputy Commissioner for interventions in the Umbrian areas struck by the earthquake, an investigation was carried out by the authors in cooperation with the RITAM laboratory located in Terni and on site tests were performed on the application of various repair and strengthening techniques for multiple leaf masonry walls. Diagonal compression, simple compression and shear-compression tests were carried out on masonry panels of various dimensions, which had been strengthened with either traditional or innovative techniques. Concerning traditional method, panel injected with new lime based mixes were tested and panels repaired by deep repointing of mortar joints.

The aim of the work was to characterise the behaviour of the masonry typical of the studied areas and to study the effectiveness of the seismic upgrading and reinforcing work both on undamaged and damaged walls. The tests carried out provided interesting indications for the practical utilisation of the studied techniques.

Only the deep repointing technique alone or combined with grout injection will be studied and reported here. The result show a significant increase in strength and stiffness compared to the un-strengthened panels.

2. Description of the technique

It is worth stating a preliminary consideration before the description of this particular technique. Once a repair technique is proposed, it should be experimentally studied to understand not only the best application procedure, but also its effectiveness. Nevertheless, in the case of a historic masonry due to its variability in materials and construction techniques no general repair method

exists, but only methods fitting the masonry characteristics. Jacketing with a reinforced cement rendering can be applied with good success to some masonry walls and fail with others; the same considerations apply for grout injections, repointing and any other technique. Therefore what is really important for the designer is to know the characteristics of the masonry to be repaired and of its components (mortar, stone, brick) before deciding.

In the cases presented here an appropriate investigation on site and in laboratory was carried out through: (i) an accurate geometrical survey of the masonry morphology (number of leaves in the section, dimension of the leaves, type of connection between the leaves), (ii) characterization of the stones and of the mortars, (iii) survey of the physical and mechanical decay, (iv) crack pattern survey.

Stones and mortars were sampled from the walls and laboratory tests were carried out. Chemical, petrographic-mineralogical analyses were performed on the mortars in order to detect their composition: type of binder, type of aggregates, binder/aggregate ratio, aggregate size and dimensions. On the stones petrographic, analysis physical and mechanical tests were performed. Based on the results of the laboratory tests, appropriate materials were chosen both for injection and repointing.

The morphology of the walls suggested that in some cases repair by injection were not appropriate due to the fact that inside the masonry there was practically loose material and no voids were present [3]. Therefore before applying the technique, appropriate tests were carried out in laboratory on sampled materials and also on site [4].

The choice of the mortar to be used for repointing is also difficult; in fact, to have good durability, this mortar must be compatible with the existing masonry from the physical, chemical

and mechanical points of view. In the case of deep repointing, the mortar should be strong enough but not too stiff, and have good bond with the stones and with the existing mortar.

In fact, the aims of the deep repointing are the following: (i) replace the damaged mortar on the wall surface to a depth of 70-80 mm in order to adequately bond in-plane the stones, (ii) confine the wall externally as a complement to injection, (iii) provide a better penetration of the grout while avoiding leakage to the exterior. When the repointing is successful, 140 mm of the wall section (in case of two leaf walls the thickness varies from 400 to 550 mm) are well bond together and constitute good confinement for vertical loads. This technique can assure a uniform distribution of the material in the external leaves. As said before, jacketing and injection are not always successful if grout cannot penetrate inside the masonry and connect the two leaves; in many cases transversal connector, are needed instead. Regardless of this, injection is necessary and effective when diffused cracks are present.

As it will be described in a following section, deep repointing and injection were carried out on site on some masonry panels isolated from masonry walls of buildings damaged by the 1997 earthquakes in Umbria. The panels were subjected to mechanical tests before and after repair in order to determine the shear strength and the elastic and shear moduli; these tests allowed also to characterize typical masonry of the region.

3. Compression, shear-compression and diagonal tests on full scale panels

Compression, shear-compression and diagonal compression tests were carried out on site with the aim of determining the shear stiffness and strength of the masonry. On site the tests were carried out on panels cut from the loadbearing walls. The operation was performed by using a special cutting techniques with diamond wires in order to avoid major damages to the panels.

Shear-compression tests (Fig. 5) were carried out on panels of 900x1800 mm dimension with thickness variable from 300 to 700 mm. During the test, the masonry was subjected to a vertical constant stress σ_0 and simultaneously to an horizontal shear load T in the centre of the panel.

This test even if it simulates better the state of stress of a masonry under horizontal loads, is much more complicated than the diagonal test.

A compression test is usually carried out before the shear-compression test on the panels without reaching the failure, in order to determine previously some masonry parameters like the elastic modulus and the Poisson's ratio. For a more detailed description of the tests, see [5].

Concerning the shear-compression test, panels of dimension 1800x900 mm can be considered as two half panels 900x900 mm, one over the other. The initial value σ_0 of the vertical stress is known:

$$\sigma_0 = \frac{P_v}{A} \quad (4)$$

where P_v is the vertical compressive load and A is the area of the transversal cross-section of the panel. From the value of the reached maximum shear load T_{iu} , the maximum shear stress is calculated for the bottom half panel in which generally the shear failure is attained before, due to the highest constraint level:

$$\tau_u = \frac{T_{iu}}{A} \quad (5)$$

Then the value of the correspondent principal tensile stress σ_I in the bottom half panel is expressed by the following relationship [6, 7]:

$$\sigma_I = \sigma_0 \left[-\frac{1}{2} + \sqrt{\left(b \frac{\tau_u}{\sigma_0} \right)^2 + \frac{1}{4}} \right] \quad (6)$$

where b is a shape factor that takes into account the variability of the shear stresses on the horizontal section of the wall. This parameter is assumed by the Italian Standards [8] and the well-known POR method equal to 1.5

Through the values obtained in (4), (5), (6), the characteristic shear stress τ_k at the bottom half panel is calculated:

$$\tau_k = \frac{\sigma_I}{b} \quad (7)$$

where

$$b = 1.543 - 0.478 \frac{\tau_u}{\sigma_0} \quad (8)$$

is the shape factor.

The shear modulus G during the elastic phase is calculated with reference to the Sheppard static scheme assuming that the lowest half panel, which is the most highly stressed, behaves as an elastic beam perfectly constrained at the bottom. This causes a lack of symmetry in the shear distribution between the upper and lower halves of the panel, which can be taken into account during the interpretation of the data. According to this hypothesis, the G modulus can be derived from (9) in which it is the only unknown:

$$\frac{\delta_E}{0.9T_{iu}} = \frac{1.2h}{GA} \left[1 + \frac{G}{1.2E} \left(\frac{h}{d} \right)^2 \right] \quad (9)$$

where d and h are the thickness and height of masonry panel; A and E are respectively the cross section area of the panel and Elastic modulus obtained from the compression test. δ_E is the relative horizontal displacement between top and middle point of the panel assuming a linear elastic behavior and it is calculated as indicated in figure 6.

The on site diagonal compression test is the most frequently used and has now been assumed also by the Italian Seismic Code due to its simplicity and by Eurocode 6 [9]. The test is also standardized by ASTM (ASTM E 519-81) [10]. The test has also been carried out by several authors in laboratory on physical models of brick and stone masonry [11, 12, 13, 14].

The diagonal test was performed on site on panels of 1200x1200 mm dimension with sections of different thickness and morphology in laboratory and on site. The load is given by hydraulic jacks (Fig. 7). In the case of the diagonal test, the calculated value of the shear stress τ is equal to the value of the principal stress σ_1 as follows:

$$\tau = \sigma_1 = \frac{P}{A\sqrt{2}} \quad (10)$$

where P is the diagonal compressive load generated by the hydraulic jack and A is the area of the horizontal cross-section of the panel. With reference to this interpretation of the test as defined by ASTM E 519-81 Standard, it is possible to calculate the characteristic strength of the masonry through :

$$\tau_k = \tau_u = \frac{P_{\max}}{A\sqrt{2}} \quad (11)$$

Furthermore it is possible to calculate the shear stiffness $G_{1/3}$ (secant value of the modulus at 1/3 of the peak load) defined as:

$$G_{1/3} = \frac{\tau_{1/3} - \tau_i}{\gamma_{1/3}} \quad (12)$$

4. Description of the tested masonry and of the repair technique

As mentioned above, the panels were subjected to the mechanical tests before and after strengthening. Some were strengthened with injections and deep repointing, and some only with

deep repointing. The grout was a ready mix hydraulic lime, the mortar for repointing was a lime-cement mortar.

4.1. Deep repointing of the panels

Fig. 8a,b shows the 70 mm deep excavation and cleaning of the joints on both sides of the panel. Fig. 8c,d show, respectively, the first and the last layering of the repointing mortar. These operations must be carried out on the whole surface of the wall on both sides in order to give effectiveness to the repair, by bonding together all the stones for the depth of the pointing. The strength of the mortar was determined from compression and flexion tests. Six 160x40x40 mm prisms were tested in flexion and six 40x40x40 mm cubes in compression. 28-day average strength results were as follows: 3.559 MPa is the flexion strength and 10.75 MPa is the compression strength.

4.2. Grout injection and deep repointing

The repair was carried out as follows: at first some diffused cracks were injected in order to avoid leakage of the grout. Then the diagonal cracks caused by the previous shear tests were injected carefully. With regard to injection grout, the following properties (average values) were provided by the supplier (Albaria Iniezione 100, Mac S.p.A.): 28-day compression strength 7 MPa, flexion strength 3 MPa, weight grout density 1850 kg/m³, elastic modulus 8000 MPa. For the injection fourteen holes were prepared on the internal side and fifteen on the external side of the wall; only three holes were injected starting from the bottom of the panel at low pressure. The other holes were used as a control of the grout distribution. Finally, the excavation of the joints was performed and then the repointing was carried out in subsequent layers. The tests were

carried out after 45 days in order to allow the grout and the mortar to harden. The repair and testing were carried out on three different buildings belonging to three historic centres of Umbria: Ponte di Postignano, Farnetta and Trevi. They are all situated in the Umbria region. In the following, a brief description of the three buildings is reported.

4.3. The Ponte di Postignano building

This building was constructed around 1950 following the construction technique used traditionally in the historic centres; the damages after the earthquake were so heavy that it was decided to demolish it. The alternative choice of repair was suggested by the presence of some external bearing walls still standing and with low damage (Fig. 9a). Another motivation for the repair alternative it should be preserved since the materials used for the wall construction were typical of the Valnerina valley: white and pink limestone, and travertine (*sponga*) present in 25-35% of the surface of the walls. The building is three floors high with stables at the ground floor. The masonry texture is made with irregularly cut stones with a maximum length of 400 mm and the wall is a double leaf masonry with weak connections between the leave. The mortar, based on putty lime, has a good consistency. The panels used for the tests were situated at the ground floor.

4.4. The Farnetta building

The second building situated in Farnetta was completed at the beginning of the 20th cent. as a rural house. The plan is rectangular with the longest side of 15 m. The building is two floors high with the ground floor used as goods storage subdivided in three rooms (Fig. 9b); the walls are

made with a two leaf masonry of irregular stones with weak connections and a thickness of 480 mm. The mortar is based on putty lime and silty sand. The panels used for testing were situated at the ground floor; three panels were tested, one under diagonal compression, one under compression, one under shear-compression.

4.5. The Trevi building

This large building in Trevi was built at the end of the 19th cent. as a dock for agricultural purposes. The plan is square and the dock is three floors high (Fig. 9c). The masonry is made with two leaves of roughly cut stones with a thickness of 670 mm. The chosen panels had some courses made with bricks at regular spacing. In the internal part of the wall section the mortar filled all the voids between the stones, but no connection was found between the two leaves of masonry.

5. Analysis of the results

In order to better describe the experimental programme, a list of the tests carried out in Ponte di Postignano, Farnetta and Trevi is presented in Table 1 together with the masonry description and the eventual type of repair. The letters CD indicate diagonal compression tests, the letters TC and CS indicate respectively shear- compression tests and compression tests. As can be seen from Table 1, the walls were tested in the undamaged state and subsequently it repaired.

In Fig. 10a,b,c the section of the walls tested in the three chosen buildings is presented. As it can be seen the walls are made with a two leaf masonry and irregular stones.

5.1 Compression test

These tests were only carried out on the Farnetta building. In detail, two panels of dimension 1800x900x480mm, were subjected to the following cycles of tests: 1) N.2 panels before reinforcing under compression, and the same two panels reinforced with deep repointing and injection under compression, 2) N.2 panels before reinforcing under shear-compression, and the same two panels reinforced with deep-repointing and injections under shear-compression.

In Table 2 the detailed results of the simple compression test before and after repair are given. In Fig. 11 the stress-strain results of the same tests are presented. It can be easily seen that the increase in elastic modulus was respectively 32 and 5.69 times. Nevertheless high scatter in the results was found, as expected from such irregular masonry.

5.2. Shear-compression test

For the case of shear-compression tests, the results are reported in Table 3. The average value of the shear strength for the un-reinforced panels is 0.086 N/mm^2 . After repair by deep repointing and injection, the average shear strength was 0.304 N/mm^2 , which is about 3.5 times, the original value. For the un-reinforced panels, the average elastic shear modulus was 51.69 N/mm^2 , while after repair is became 289 N/mm^2 . Here also a high scatter in the results was found.

5.3. Diagonal compression test

These tests were carried out in the two buildings of Ponte and Trevi. The first two tests were performed on the Ponte building where a masonry panel was subjected to the diagonal tests before reinforcement (CD-13-P-ORI). The values are reported in Table 4. The shear strength was 0.059 N/mm^2 , while the shear modulus was 37 N/mm^2 . After repair by deep repointing and

injection (CD-13-P-SIR) the two values became, respectively, 0.157 and 731 N/mm². The high increase both in strength and stiffness is evident.

Finally the last two diagonal tests were carried out on the Trevi building (CD-26-T-ORI, CD-26-T-RIR). The panel with a thickness of 670 mm was only repaired by deep repointing in order to check the influence of the technique when used alone. The results are also reported in Table 4. In this case the shear strength change from the un-repaired panel to the panel after repair, is from 0.045 N/mm² to 0.054 N/mm², which is only a very small increase in value. On the contrary, the shear stiffness changed from 79.60 N/mm² to 231.56 N/mm². Figs. 12 and 13 show the comparison of the stress-strain curves of the panels in Trevi and Ponte.

From these results, a clear tendency is shown: the deep repointing alone can increase the shear stiffness of the masonry, while a significant increase in shear strength can be obtained by the synergic effect of repointing and grout injection. It is nevertheless important before using the grout injection technique to accurately examine its applicability. In fact when the technique was applied by the authors always a study of masonry injectability was carried out [4]. A certain percentage of voids must be present in the masonry and no loose material or clay must be found inside the masonry section, in order to have a successful injection. The results obtained for the diagonal compression tests carried out on panels repaired by means of injection and deeprepointing showed significant high increases both in terms of shear strength and stiffness. However, it must be pointed out that the presence of cracks (these cracks were caused by the initially tests on the same un-strengthened panels) facilitated the distribution of the injected grout within the panels.

5.4. Inspection of the repaired panels

After testing of the repaired panels, some of them were cut from the wall and taken to the laboratory in order to control the penetration and diffusion of the repointing and of the injection. Fig. 14a shows the cutting of the panel in different portions which were carefully examined to check the penetration and bonding of the repointing. Fig. 14b and c show, respectively, the depth of penetration and the good bond between the new and the existing mortar. It seems that the deep repointing technique has a higher probability of being successful than the injection technique. Of course the two can be complementary.

6. Conclusions

The experimental results have shown that a deep repointing up to a depth of 70 to 80 mm produces a significant increase of the shear strength and especially of the shear stiffness of masonry made with roughly cut stones compared to the virgin masonry. The results obtained for the diagonal compression tests carried out on the panel repaired by means of injection and deep repointing showed significant increase both in terms of shear strength and stiffness. It is significant to note that the injection and deep repointing techniques, when applied to suitable masonry, causes a strong increase in shear stiffness. Panels repaired with this technique and re-tested showed increases with minimum values of 3 times superior to those obtained on the same panels previously tested before strengthening. This important aspect should be further analyzed, considering its effects on the stiffness redistribution among the various walls stressed by seismic action. However, it must be pointed out that the presence of cracks caused by the test on the un-strengthened panels, facilitated the distribution of the injected grout within the panels. The technique is more effective when the wall thickness is small and when coupled with injections (provided that the wall is injectable). The deep repointing seems to be a very interesting technique for some masonry typologies.

7. References

- [1] Binda L., Cardani G., Penazzi D., Saisi, A. Performance of some repair and strengthening techniques applied to historical stone masonries in seismic areas, ICPCM a New Era of Building, Cairo, Egypt, 18-20/2/2003, Vol. 2, pp. 1195-1204.
- [2] Vintzileou E., Tassios T.P. Three-leaf stone masonry strengthened by injecting cement grout. J. of structural engineering. ASCE, 121 (5), 1995, 848-856.
- [3] Abbaneo S., Baronio G., Binda L., Tiraboschi C. Murature in pietra: classificazione ed indagini preliminari per la scelta e la progettazione delle miscele di iniezione. Convegno Murature, Sicurezza, recupero, Trento, 1993, 185-222.
- [4] Laefer D., Baronio G., Anzani A., Binda L. Measurement of grouts injection efficacy for stone masonry wall, Conv. 7NAMC, Notre Dame, USA, 1996, Vol.1, pp. 484-496.
- [5] Corradi M., Borri A., Vignoli A. Experimental study on the determination of strength of masonry walls, Construction and Building Materials, 2003, 17, 325-337.
- [6] Turnsek V., Sheppard P.F. The shear and flexural resistance of masonry walls, Proc. Research Conference on Earthquake Eng., Skopje, 1980, 517-573.
- [7] Chiostrini S., Galano L., Vignoli, A. On the determination of strength of ancient masonry walls via experimental tests. Proc. 12th World Conference on Earthquake Engineering, Auckland, New Zealand, 2000, n.2564.
- [8] Circolare LL. PP. 30 Luglio 1981, (1981). Normativa per le riparazioni ed il rafforzamento degli edifici danneggiati dal sisma nelle regioni Basilicata, Campania e Puglia. G.U. 21.07.1981, n. 198.
- [9] Eurocode 6 (1995). Design of masonry structures – Part 1-1: General rules for buildings – Rules for reinforced and unreinforced masonry. ENV 1996-1-1:1995.
- [10] ASTM E 519-81. Standard Test Method for Diagonal Tension (Shear) in Masonry Assemblages, American Society for Testing Materials, 1981.
- [11] Corradi M., Borri A., Vignoli A. Strengthening techniques tested on masonry structures struck by the Umbrian-Marche earthquake of 1997-1998, Construction and Building

Materials, 2002, 16/4 , 229-239.

- [12] Valluzzi M.R., Tinazzi D., Modena C. Shear behavior of masonry panels strengthened by FRP laminates, *Construction and Building Materials* 16 (2002) 409–416.
- [13] Tomazevic M., Lutman M., Pertrovic L. In plane behavior of reinforced masonry walls subjected to cyclic lateral loads. Report to the Ministry of Science and Technology of Republic of Slovenia, parts 1 and 2. Ljubljana, Slovenia, 1993.
- [14] Triantafillou TC. Strengthening of masonry structures using epoxy-bonded FRP laminates. *J Compos Constr ASCE*, 1998;2(2):96 –104.



Figure 1 Double leaf wall



Figure 2 Effect of eccentric loading due to RC tie beam positioning.



Figure 3 Only some spots were injected in the case of this wall with a very low percentage of voids.



Figure 4 Failure of jacketing

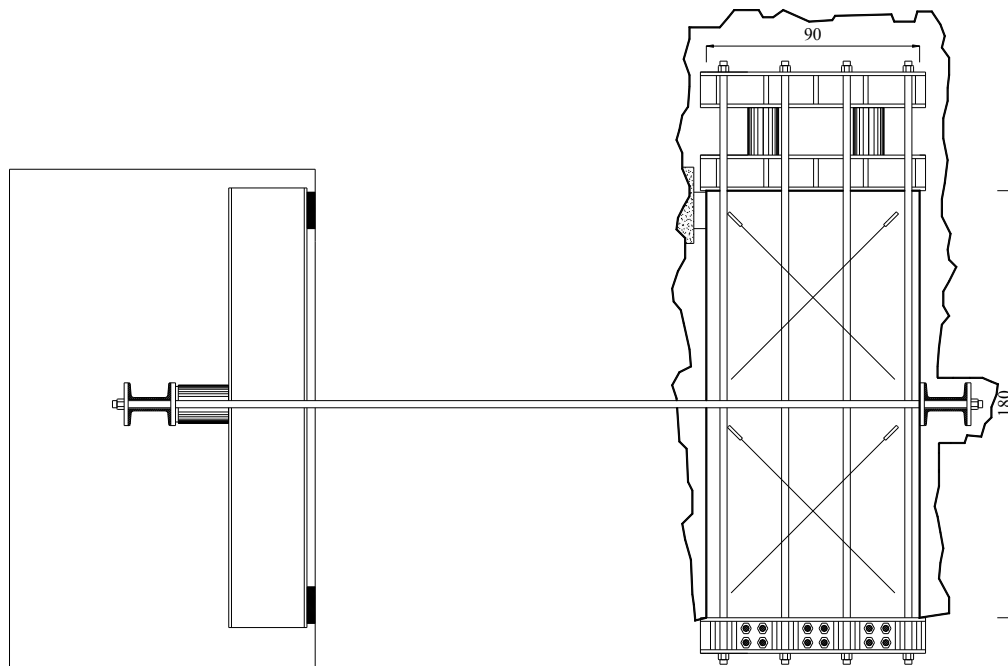

Figure 5 Shear compression test layout.

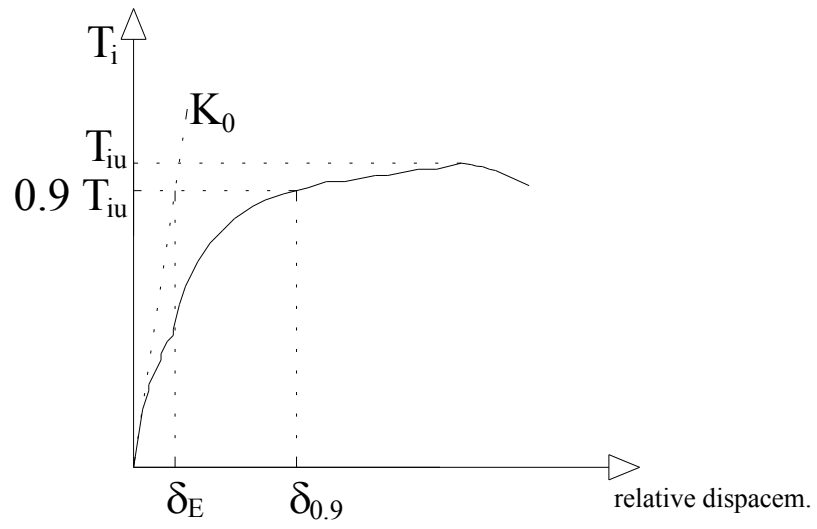

Figure 6 δ_E calculation procedure.

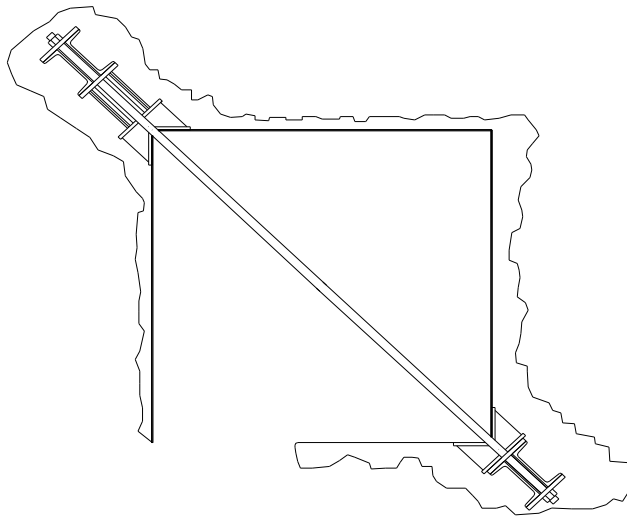

Figure 7 Diagonal compression test layout.

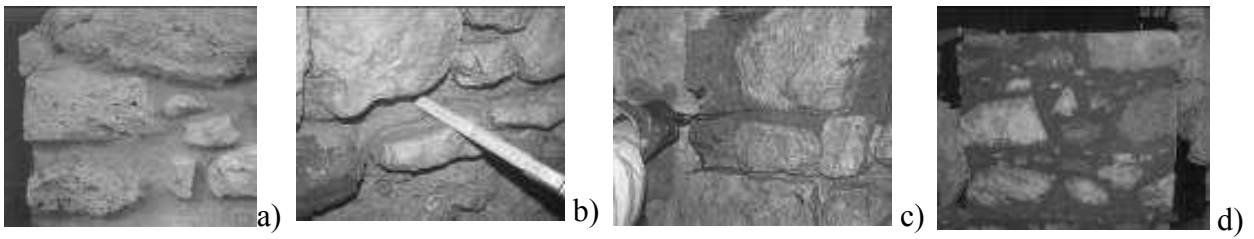

Figure 8 (a) Joint after cleaning, (b) detail of the joint depth, (c) first layer of repointing, (d) after intervention.



a)



b)



c)

Figure 9 a) Ponte di Postignano bulding; b) Farnetta building; c) Trevi building.



a)



b)



c)

Figure 10a,b,c Section analysis: a) Ponte di Postignano; b) Farnetta c) Trevi;

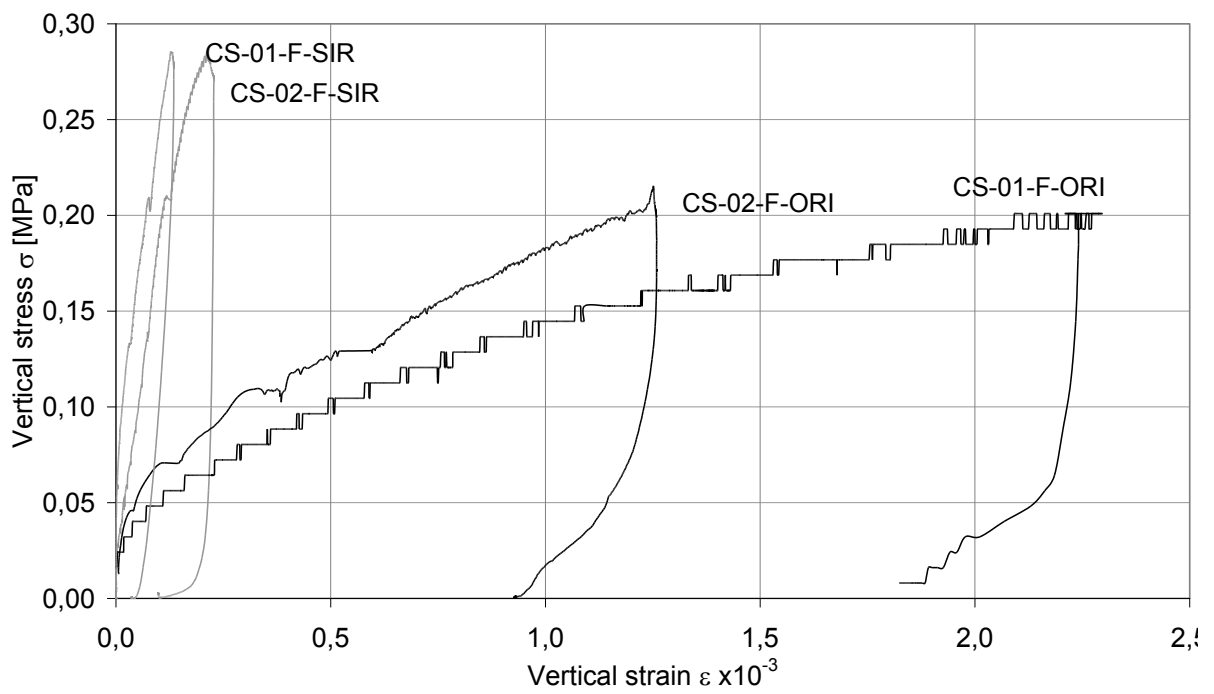

Figure 11 Compression tests: vertical stress vs strain.

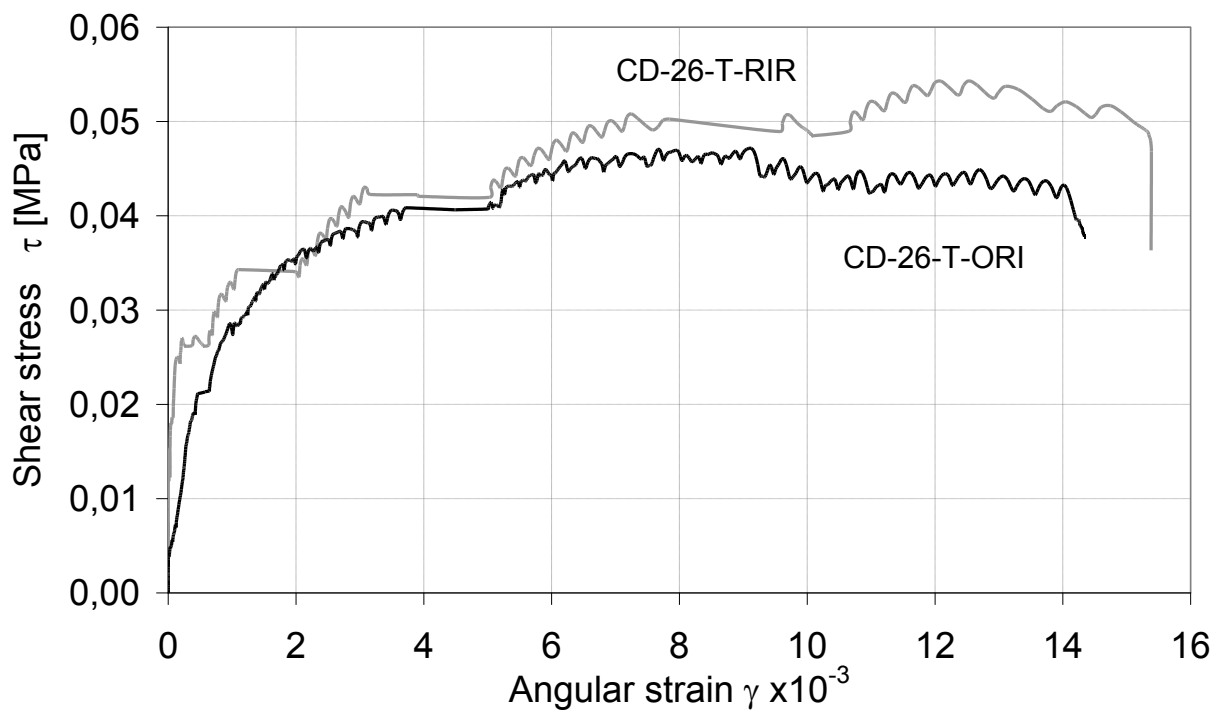

Figure 12 Angular strain vs shear stress for the Trevi panel before and after reinforcement.

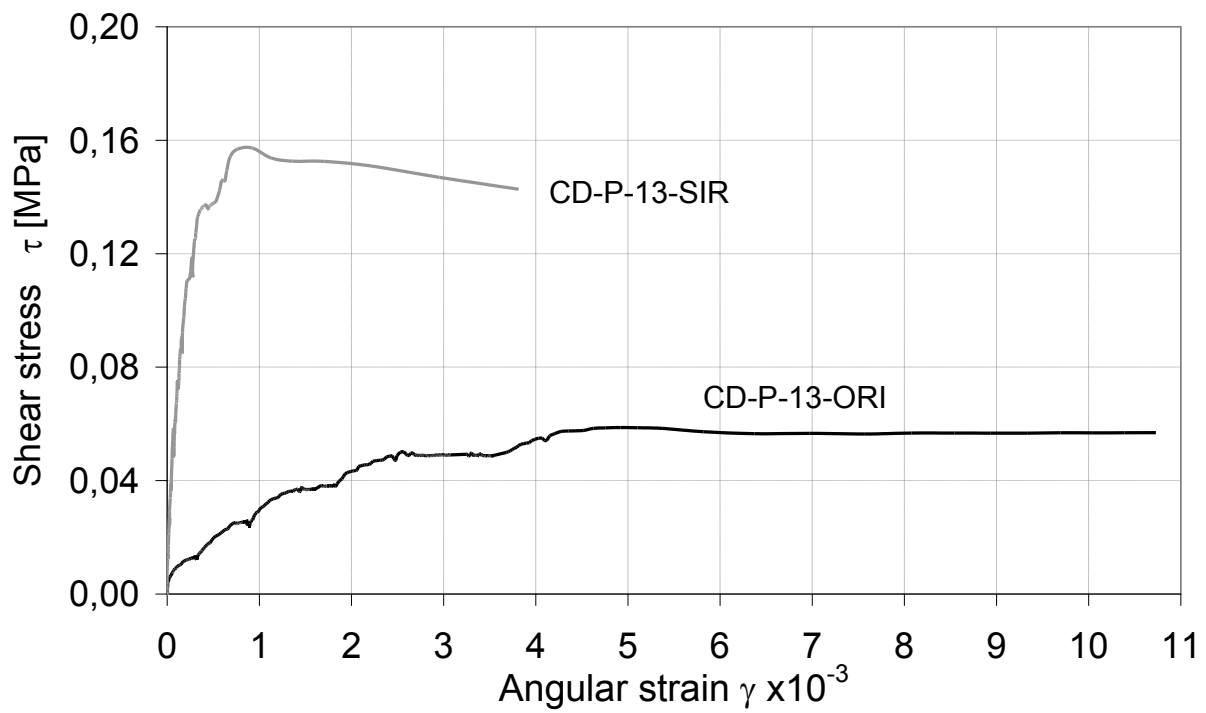

Figure 13 Angular strain vs shear stress for the Ponte panel before and after reinforcement.

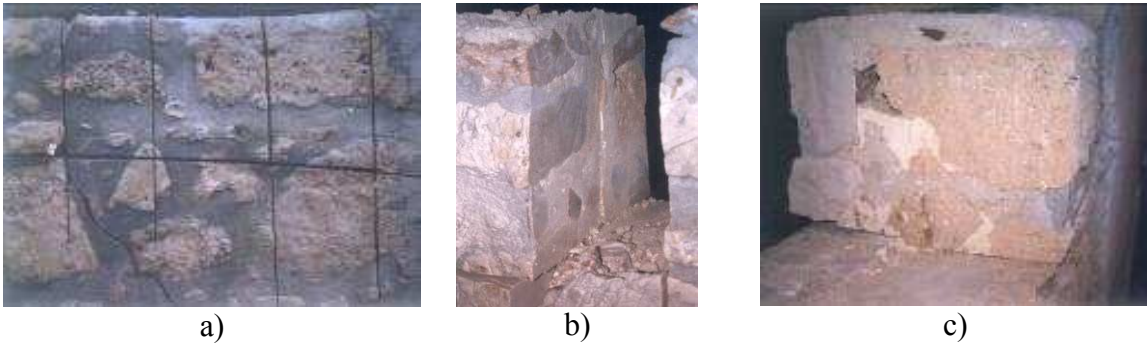

Figure 14 a) Cutting of the panel in different portions; b) depth of penetration; c) good bond between the new and the existing mortar.

Table 1 - Reinforcement and panel characteristics

Test No.	Building location	Reinforcement	Masonry texture
CD-13-P-ORI	Ponte di Post.	before repair	Double-leaf roughly cut
CD-13-P-SIR	Ponte di Post.	deep repointing + grout injections	stone masonry
CD-26-T-ORI	Trevi	before repair	Double-leaf roughly cut
CD-26-T-RIR	Trevi	deep repointing	stone masonry
TC-01-F-ORI	Farnetta	before repair	Double-leaf roughly cut
TC-01-F-SIR	Farnetta	deep repointing + grout injections	stone masonry
TC-02-F-ORI	Farnetta	before repair	Double-leaf roughly cut
TC-02-F-SIR	Farnetta	deep repointing + grout injections	stone masonry
CS-01-F-ORI	Farnetta	before repair	Double-leaf roughly cut
CS-01-F-SIR	Farnetta	deep repointing + grout injections	stone masonry
CS-02-F-ORI	Farnetta	before repair	Double-leaf roughly cut
CS-02-F-SIR	Farnetta	deep repointing + grout injections	stone masonry

Table 2 - Results of simple compression tests

Test No.	Panel dimensions (cm)	Vertical stress applied σ_0 (MPa)	Young modulus E (MPa)
CS-01-F-ORI	86x48x182	0.201	1289
CS-01-F-SIR	86x48x182	0.286	4153
CS-02-F-ORI	86.3x48x180	0.215	306
CS-02-F-SIR	86.3x48x180	0.286	1770

Table 3 - Results of shear-compression tests.

Test No.	Panel dimensions (cm)	Max shear strength τ_u (MPa)	Vertical stress applied σ_0 (MPa)	Shear strength τ_k (MPa) $b=1.5$	Shear elastic modulus G (MPa)
TC-01-F-ORI	86x48x182	0.083	0.147	0.047	37.9
TC-01-F-SIR	86x48x182	0.412	0.272	0.331	281.4
TC-02-F-ORI	86.3x48x180	0.089	0.184	0.047	65.4
TC-02-F-SIR	86.3x48x180	0.196	0.268	0.103	196.1

Table 4 - Results of diagonal compression tests.

Test No.	Panel thickness (cm)	Shear strength τ_K (MPa)	Shear elastic modulus $G_{1/3}$ (MPa)	Angular strain $\gamma_{1/3}$
CD-13-13-ORI	48	0.059	37	0.533
CD-13-13-SIR	48	0.157	731	0.070
CD-26-T-ORI	67	0.045	80	0.190
CD-26-T-RIR	67	0.054	232	0.076